



ED-MONITOR-070C

User Manual

by EDA Technology Co., Ltd

built: 2025-08-01

1 Hardware Manual

This chapter introduces the product overview, packaging list, appearance, buttons, indicators, and interfaces.

1.1 Overview

The ED-MONITOR-070C is a 7-inch industrial touch monitor featuring a screen resolution of 1024×600, a high brightness of 425 cd/m², and a multi-touch capacitive touch screen. It includes one standard HDMI interface, one Type-C USB port, one DC Jack power interface, and one 3.5mm audio jack, making it compatible with various general-purpose PC hosts. The backlight can be adjusted via buttons, and it is primarily used in industrial control applications.

- The HDMI interface allows direct connection to the HDMI output of a PC host.
- The Type-C USB port transmits touch screen signals.
- The 3.5mm audio jack supports headphone connectivity.
- The DC Jack power interface supports 12V~24V DC input.

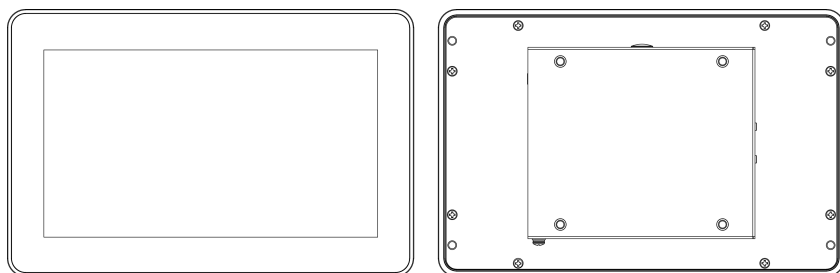

1.2 Packing List

- 1 x ED-MONITOR-070C Monitor

1.3 Appearance

This section introduces the functions and definitions of the interfaces on each panel.

1.3.1 Front Panel

Introducing the types and definitions of the interfaces on the front panel.

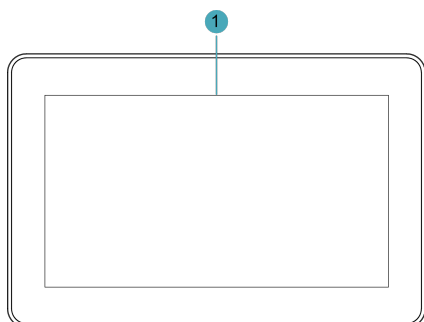

NO.	Description
1	1 × LCD screen, 7-inch touch screen with a resolution of 1024×600, multi-touch capacitive touch screen.

1.3.2 Rear Panel

Introducing the types and definitions of the interfaces on the rear panel.

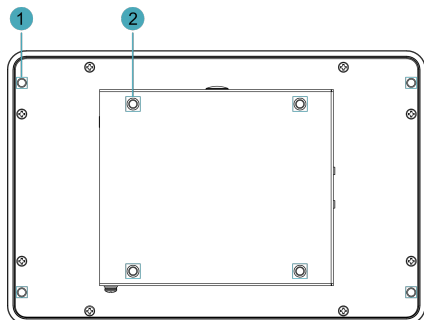

NO.	Description
1	4 x installation holes of snap, which are used to fix the snaps to the device for installation.
2	4 x VESA mounting holes, reserved for VESA bracket installation.

1.3.3 Side Panel

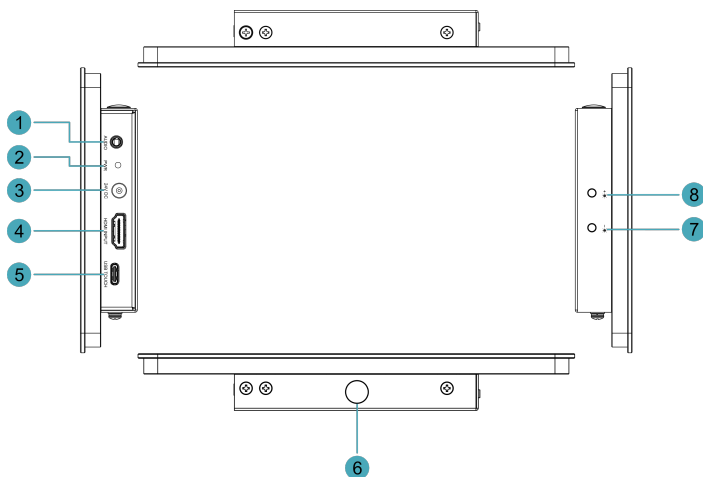

Introducing the types and definitions of the interfaces on the side panel.



NO.	Description
1	1 × 3.5mm stereo audio output jack, supports headphone connectivity.
2	1 × red power indicator, using to view the device's power-on and power-off status.
3	1 × DC input, DC Jack connector, which supports 12V~24V DC input.
4	1 × HDMI input, Type-A connector, which connects to the HDMI output of a PC host.

NO.	Description
5	1 × USB touch screen port, Type-C USB connector, which connects to the USB port of a PC host to transmit touch screen signals.
6	1 × Rubber plug (pre-drilled 7mm diameter circular cable routing hole), designed to accommodate additional cable management needs.
7	1 × "Brightness -" button, press the button to decrease the backlight brightness of the LCD screen.
8	1 × "Brightness +" button, press the button to increase the backlight brightness of the LCD screen.

1.4 Button

The ED-MONITOR-070C device includes two backlight brightness adjustment buttons. The buttons are black in color and marked with screen-printed labels  and  on the housing.

Button	Description
	Press the button to increase the backlight brightness of the LCD screen.
	Press the button to decrease the backlight brightness of the LCD screen.

1.5 Indicator

The ED-MONITOR-070C device includes a red power indicator, marked with the screen-printed label "PWR" on the housing.

Indicator	Status	Description
PWR	On	The device has been powered on.
	Blink	Power supply of the device is abnormal, please stop the power supply immediately.
	Off	The device is not powered on.

1.6 Interface

Introducing the definitions and functions of each interface in the ED-MONITOR-070C.

1.6.1 Power Interface

The ED-MONITOR-070C device includes 1 power input port with a DC Jack connector, labeled "24V DC" on the housing. It supports 12V~24V DC input.

TIP

A 12V 2A power adapter is recommended.

1.6.2 HDMI Interface

The ED-MONITOR-070C device includes 1 HDMI input interface with a Type-A connector, labeled "HDMI INPUT" on the housing, used to connect to the HDMI output of a PC host.

1.6.3 Type-C USB Interface

The ED-MONITOR-070C device includes 1 Type-C USB interface, labeled "USB TOUCH" on the housing. This interface connects to the USB port of a PC host to transmit touch screen signals.

1.6.4 Audio Interface

The ED-MONITOR-070C device includes 1 audio interface (3.5mm 4-pole headphone jack), labeled "AUDIO" on the housing, supporting stereo audio output.

2 Installing the device

The ED-MONITOR-070C device supports front embedded installation. The standard packaging does not include the embedded installation Mounting kit (ED-ACCHMI-Front). Please purchase the ED-ACCHMI-Front kit in advance.

Preparation:

- The ED-ACCHMI-Front Mounting kit has been acquired (includes 4 × M4*10 screws, 4 × M4*16 screws, and 4 snaps).
- A cross screwdriver has been prepared.

Steps:

1. Determine the cutout dimensions on the cabinet based on the ED-MONITOR-070C's size, as shown in the figure below.



2. Drill holes on the cabinet according to the aperture size defined in Step 1.
3. Embed the ED-MONITOR-070C into the cabinet from the exterior side.

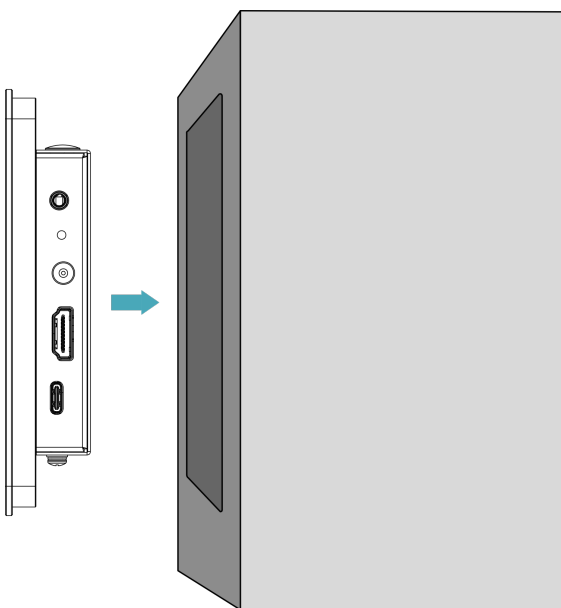

4. Align the screw holes (non-threaded) of the snaps with the snap mounting holes on the device side.

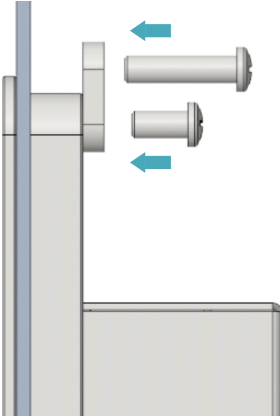

5. Secure the snaps to the device.

- Use 4 × M4*10 screws to fasten the snaps to the device by threading them through the non-threaded holes and tightening them clockwise.
- Then, use 4 × M4*16 screws to secure the snaps to the cabinet: Insert them through the threaded holes of the snaps, press against the interior side of the cabinet, and thread them clockwise until fully tightened.

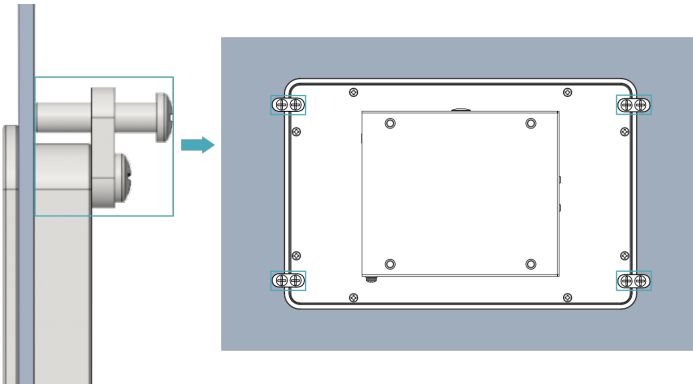

3 Using the device

The ED-MONITOR-070C requires a PC host for operation and does not require driver installation. Connect it to the HDMI output of a PC host first, then power on the device to enable normal display. It supports backlight adjustment via dedicated buttons and software.

3.1 Connecting Cables

This section describes how to connect cables.

Preparation:

- A functional power adapter has been acquired.
- A functional PC host has been acquired.
- Functional HDMI and USB cables (Type-A to Type-C USB cable) have been acquired.

Schematic diagram of connecting cables:

Please refer to [1.6 Interface](#) to obtain the pin definitions and wiring methods of each interface.

TIP

The HDMI INPUT interface of the ED-MONITOR-070C is compatible with various PC hosts. The figure below illustrates cable connection using a Raspberry Pi as an example.

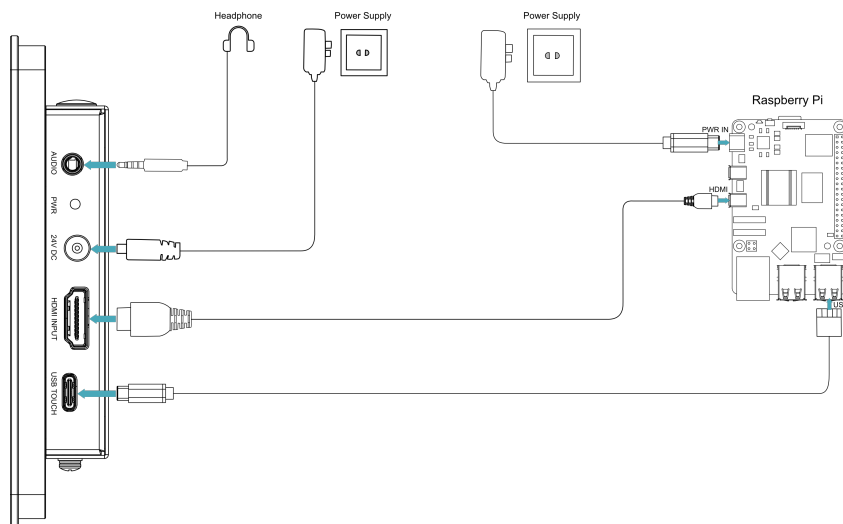

3.2 Booting the device



The ED-MONITOR-070C does not include a physical power switch. After connecting to a power source, the device will automatically power on. Once fully booted, it will display the desktop of the connected PC host.

3.3 Adjusting Backlight Brightness

ED-MONITOR-070C supports brightness adjustment via physical buttons and software.

3.3.1 Button-Based Brightness Adjustment

Once the ED-MONITOR-070C is connected to a PC and displays normally, its backlight brightness can be adjusted using the two dedicated brightness adjustment buttons on the side panel.

Button	Description
	Press the button to increase the backlight brightness of the LCD screen.
	Press the button to decrease the backlight brightness of the LCD screen.

3.3.2 Software-Based Brightness Adjustment

After connecting the ED-MONITOR-070C to a PC host and ensuring normal display operation, the screen backlight can be adjusted via software. Note that the operation methods differ between the Desktop and Lite versions of the operating system.

3.3.2.1 Raspberry Pi OS (Desktop)

Adjusting backlight brightness via UI on Raspberry Pi OS (Desktop).

Preparation:

- ED-MONITOR-070C is properly connected to the Raspberry Pi host with normal display output.
- The Raspberry Pi host has stable network connectivity.

Steps:

1. Add EDATEC apt repository by executing the following commands sequentially in the terminal.

```
curl -sS https://apt.edatec.cn/pubkey.gpg | sudo apt-key add -
echo "deb https://apt.edatec.cn/raspbian stable main" | sudo tee /etc/apt/sources.list.d/edatec.list
sudo apt update
```

2. Install the software toolkit.

```
sudo apt install -y ed-ddcci-tool
```

3. Click the  icon in the top-left desktop corner. Then select to "System Tools" → "EDATEC Monitor".

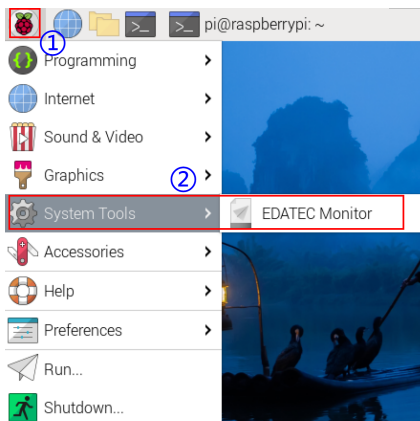

4. Adjust brightness using the slider in the "EDATEC Backlight" panel.

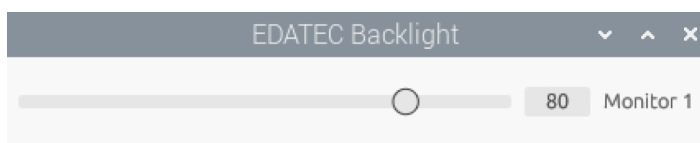

TIP

Support executing the `sudo ed-ddc-ui` command in the terminal window to open the "EDATEC Backlight" panel.

3.3.2.2 Raspberry Pi OS (Lite)

Adjusting backlight brightness via CLI on Raspberry Pi OS (Lite).

Preparation:

- ED-MONITOR-070C is properly connected to the Raspberry Pi host with normal display output.
- The Raspberry Pi host has stable network connectivity.

Steps:

1. Add EDATEC apt repository by executing the following commands sequentially in the terminal.

```
curl -sS https://apt.edatec.cn/pubkey.gpg | sudo apt-key add -
echo "deb https://apt.edatec.cn/raspbian stable main" | sudo tee /etc/apt/sources.list.d/edatec.list
sudo apt update
```

2. Install the software toolkit:

```
sudo apt install -y ed-ddcci-tool
```

3. Query current brightness level:

```
sudo ed-ddc-server brightness read
```

sh

4. Set brightness level:

```
sudo ed-ddc-server brightness write -v X
```

sh

X represents brightness level (0 = minimum, 100 = maximum).