

TO-92 Plastic-Encapsulate Transistors

2N3904 TRANSISTOR (NPN)

FEATURE

- NPN silicon epitaxial planar transistor for switching and Amplifier applications
- As complementary type, the PNP transistor 2N3906 is Recommended
- This transistor is also available in the SOT-23 case with the type designation MMBT3904

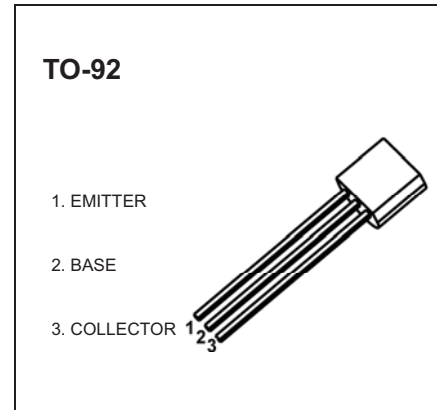

MARKING

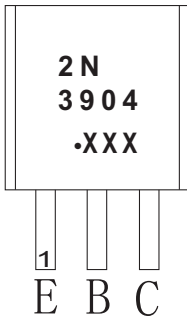

2N3904=Device code
 Solid dot=Green molding compound device, if none,the normal device
 XXX=Code

Equivalent Circuit

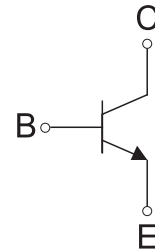

ORDERING INFORMATION

Part Number	Package	Packing Method	Pack Quantity
2N3904	TO-92	Bulk	1000pcs/Bag
2N3904-TA	TO-92	Tape	2000pcs/Box

MAXIMUM RATINGS (T_a=25°C unless otherwise noted)

Symbol	Parameter	Value	Unit
V _{CB0}	Collector-Base Voltage	60	V
V _{CE0}	Collector-Emitter Voltage	40	V
V _{EB0}	Emitter-Base Voltage	6	V
I _C	Collector Current -Continuous	0.2	A
P _C	Collector Power Dissipation	0.625	W
T _J	Junction Temperature	150	°C
T _{stg}	Storage Temperature	-55-150	°C

ELECTRICAL CHARACTERISTICS

$T_a=25^\circ\text{C}$ unless otherwise specified

Parameter	Symbol	Test conditions	Min	Typ	Max	Unit
Collector-base breakdown voltage	$V_{(BR)CBO}$	$I_C=10\mu\text{A}, I_E=0$	60			V
Collector-emitter breakdown voltage	$V_{(BR)CEO}$	$I_C=1\text{mA}, I_B=0$	40			V
Emitter-base breakdown voltage	$V_{(BR)EBO}$	$I_E=10\mu\text{A}, I_C=0$	6			V
Collector cut-off current	I_{CBO}	$V_{CB}=60\text{V}, I_E=0$			0.1	μA
Collector cut-off current	I_{CEX}	$V_{CE}=30\text{V}, V_{EB(off)}=3\text{V}$			0.05	μA
Emitter cut-off current	I_{EBO}	$V_{EB}=5\text{V}, I_C=0$			0.1	μA
DC current gain	h_{FE1}	$V_{CE}=1\text{V}, I_C=10\text{mA}$	100		400	
	h_{FE2}	$V_{CE}=1\text{V}, I_C=50\text{mA}$	60			
	h_{FE3}	$V_{CE}=1\text{V}, I_C=100\text{mA}$	30			
Collector-emitter saturation voltage	$V_{CE(sat)}$	$I_C=50\text{mA}, I_B=5\text{mA}$			0.3	V
Base-emitter saturation voltage	$V_{BE(sat)}$	$I_C=50\text{mA}, I_B=5\text{mA}$			0.95	V
Transition frequency	f_T	$V_{CE}=20\text{V}, I_C=10\text{mA}, f=100\text{MHz}$	300			MHz
Delay Time	t_d	$V_{CC}=3\text{V}, V_{BE}=0.5\text{V},$			35	ns
Rise Time	t_r	$I_C=10\text{mA}, I_{B1}=1\text{mA}$			35	ns
Storage Time	t_s	$V_{CC}=3\text{V}, I_C=10\text{mA}$			200	ns
Fall Time	t_f	$I_{B1}=I_{B2}=1\text{mA}$			50	ns

CLASSIFICATION OF h_{FE1}

Rank	O	Y	G
Range	100-200	200-300	300-400

Typical Characteristics

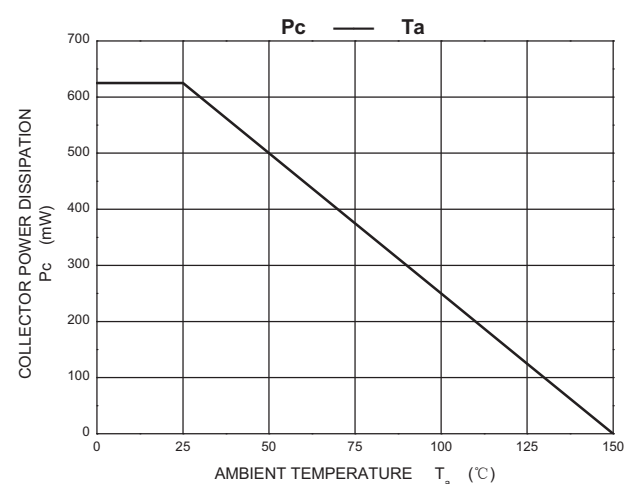
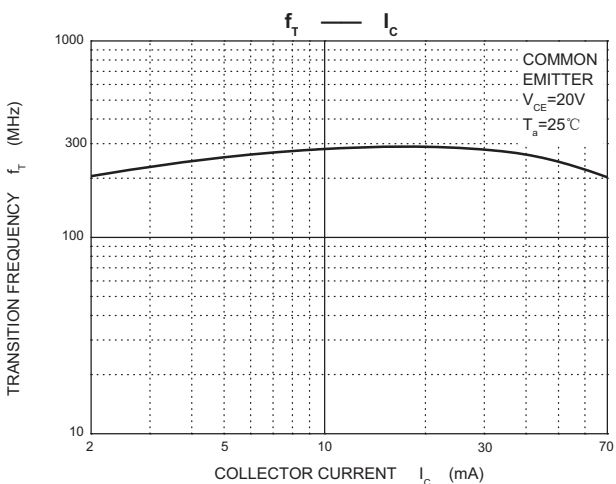
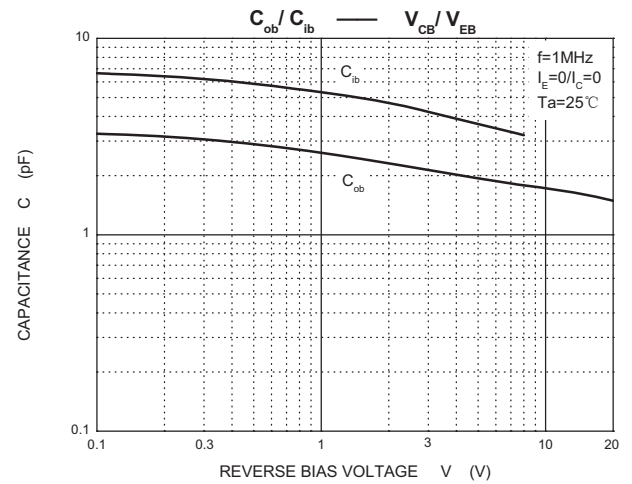
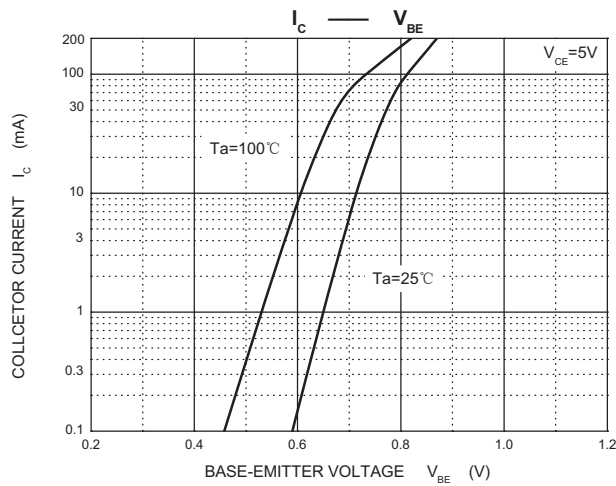
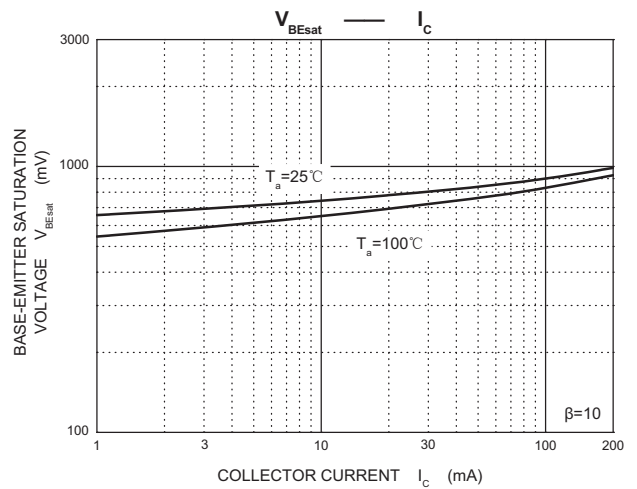
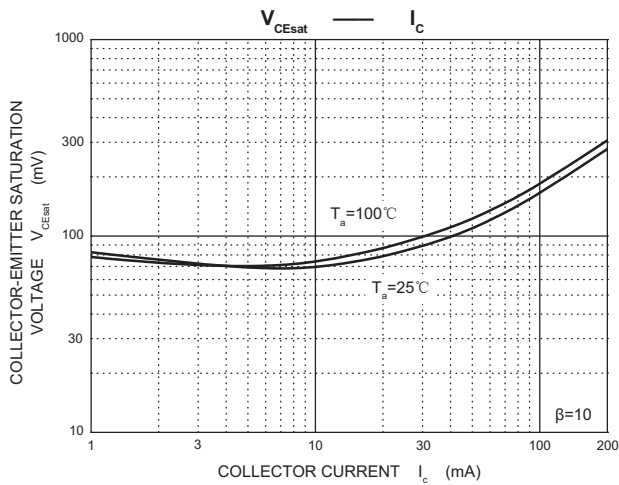
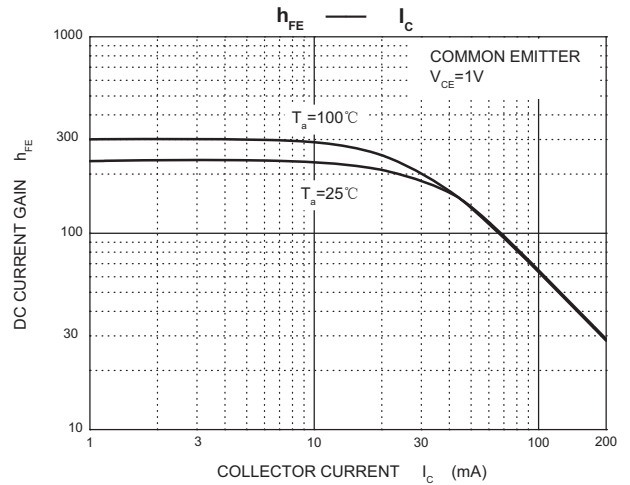
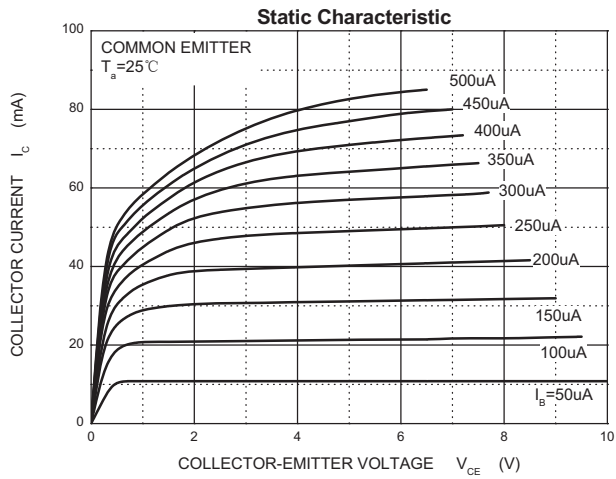

TO-92 Package Outline Dimensions

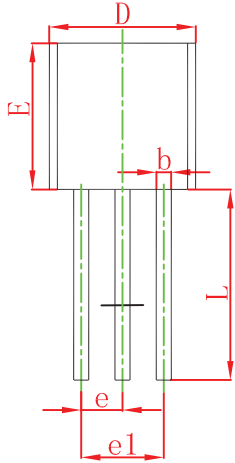
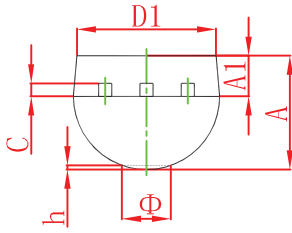

Symbol	Dimensions In Millimeters		Dimensions In Inches	
	Min	Max	Min	Max
A	3.300	3.700	0.130	0.146
A1	1.100	1.400	0.043	0.055
b	0.380	0.550	0.015	0.022
c	0.360	0.510	0.014	0.020
D	4.300	4.700	0.169	0.185
D1	3.430		0.135	
E	4.300	4.700	0.169	0.185
e	1.270 TYP		0.050 TYP	
e1	2.440	2.640	0.096	0.104
L	14.100	14.500	0.555	0.571
Φ		1.600		0.063
h	0.000	0.380	0.000	0.015

TO-92 Suggested Pad Layout

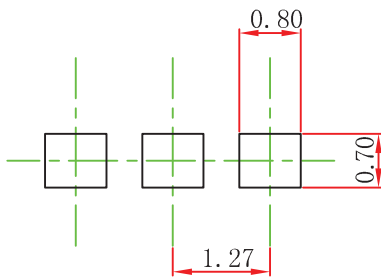

Note:

1. Controlling dimension: in millimeters.
2. General tolerance: $\pm 0.05\text{mm}$.
3. The pad layout is for reference purposes only.

NOTICE

JCET reserve the right to make modifications, enhancements, improvements, corrections or other changes without further notice to any product herein. JCET does not assume any liability arising out of the application or use of any product described herein.

TO-92 PACKAGE TAPEING DIMENSION

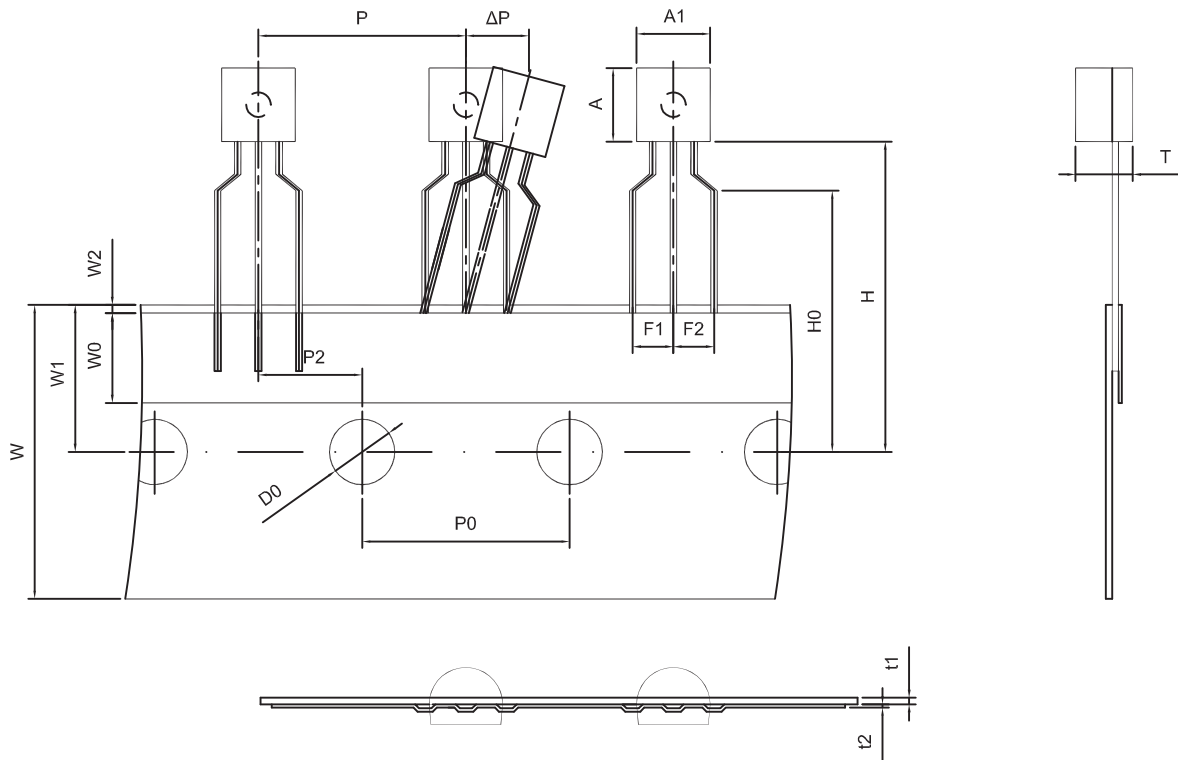

Dimensions are in millimeter								
A1	A	T	P	P0	P2	F1	F2	W
4.5	4.5	3.5	12.7	12.7	6.35	2.5	2.5	18.0
W0	W1	W2	H	H0	D0	t1	t2	ΔP
6.0	9.0	1.0 MAX.	19.0	16.0	4.0	0.4	0.2	0

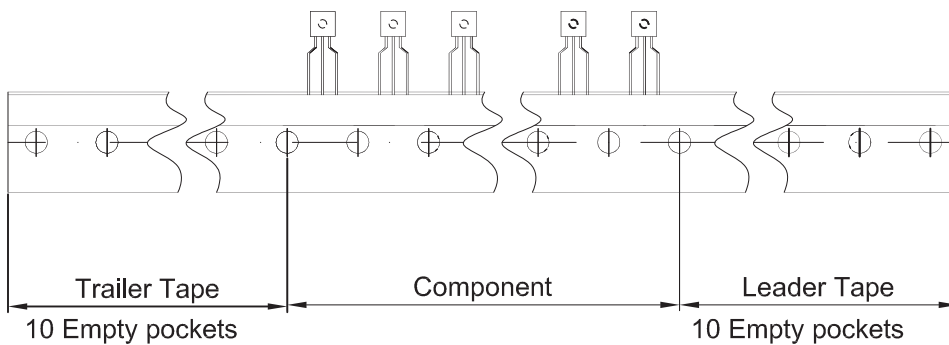

Package	Box	Box Size(mm)	Carton	Carton Size(mm)
TO-92	2000 pcs	333×162×43	20,000 pcs	350×340×250