

SECTION A-A

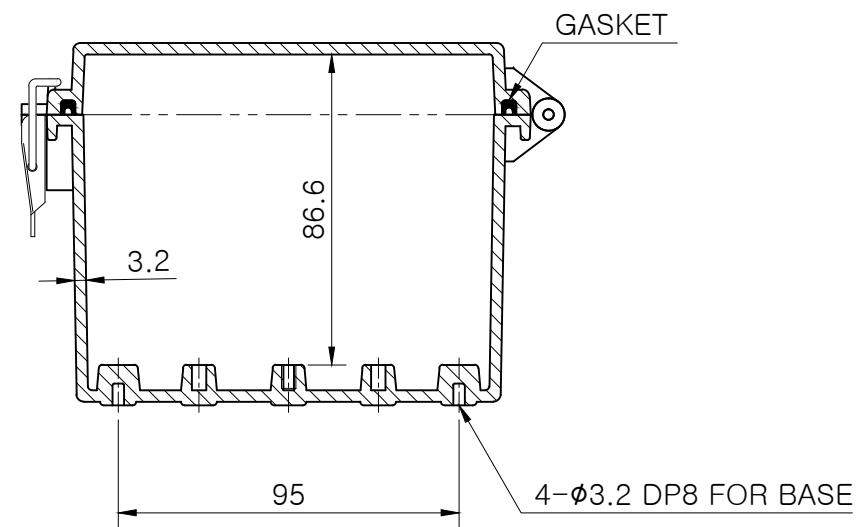
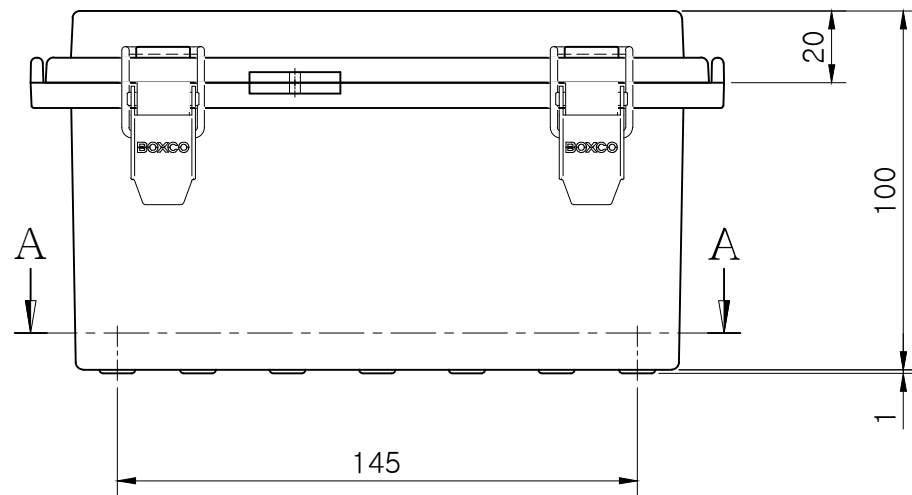

SECTION B-B

Note.

MODEL (모델)	BC-□□P-131810		D R (제도)	JUNG,Y.J.	16.04.04	UNIT (단위)	mm
ASSY (완성 규격)	135 * 185 * 100		C K (검도)	PARK,Y.J.	16.04.04	SCALE (척도)	1:2
DWG NO (도번)	P-131810-03	MATERIAL (재질)	A P (승인)	KIM,D.S.	16.04.05	REV. (개정)	0

BOXCO[®]